

# M9 Advanced

Premium Compact Ultrasound System



powerful | versatile | mobile

**mindray**

## powerful | versatile | mobile

### Powerful Platform

With the next generation of technologies, the Mindray M9 offers users a fully featured platform with premium image quality. Advanced signal processing and newly designed adaptive algorithms raise the M9 to a new level of overall performance. Combined with single crystal transducers with 3T™ technology, this compact portable ultrasound system delivers deeper penetration and higher resolution, ensuring diagnostic confidence – even in technically difficult patients.

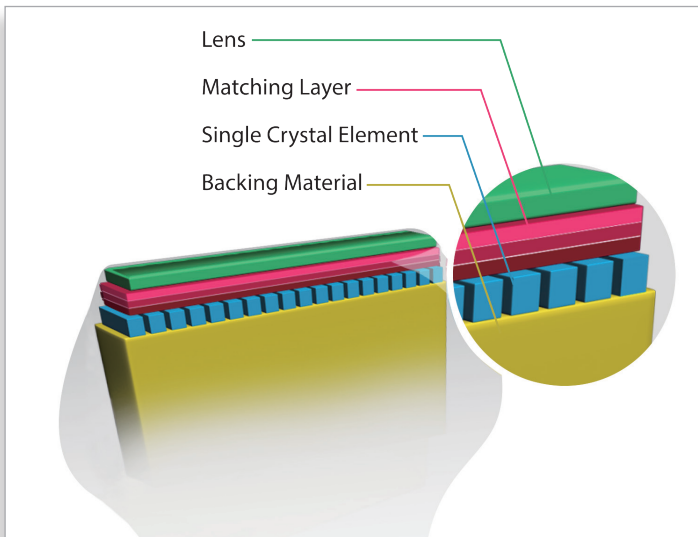

Single Crystal 3T™ Transducer Technology

### Single Crystal Transducer with 3T™ Technology Provides Sharper Images

Enhanced with the addition of single crystal technology, the transducer offers improved penetration with significant noise reduction, especially for technically difficult patients.

- Triple-matching layer design for higher sensitivity, wider bandwidth, and improved signal-to-noise ratio
- Total-cut design for lower cross-talk noise, improved directivity, and improved lateral resolution
- Thermal-control design for improved acoustic transmission and higher signal-to-noise ratio

powerful | **versatile** | mobile

The M9 is a versatile system equipped with highly focused features for dedicated applications.

## Echocardiography

### Advanced Cardiac Imaging

Echo Boost™ cardiac image optimization is the result of new adaptive algorithms that reduce noise in the heart chambers and the overall image during every frame of acquisition.

- Improves overall contrast resolution
- Improves speckle homogeneity throughout the image

### LVO with Stress Echocardiography

The M9's premium capabilities allow contrast LV opacification during stress examinations, enhancing differentiation between tissue and the blood pool, providing better visualization of the endocardium.

- Customizable user protocols
- Flexible wall motion scoring
- Comprehensive reporting package
- LVO UWN+ contrast imaging (ultra-wideband non-linear plus)

### Tissue Tracking with Quantitative Analysis

Supported by Mindray's single crystal 3T technology, the M9 significantly improves tracking accuracy and effectiveness. With the added benefit of on-site analysis, tissue tracking can be performed at bedside, saving time and simplifying challenging outcomes.

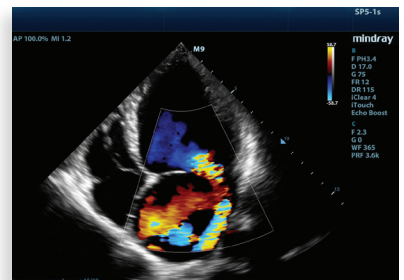

Four chamber view of mitral valve regurgitation

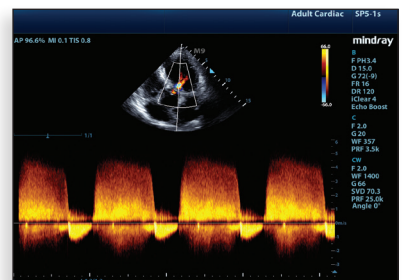

SCW Doppler for aortic regurgitation

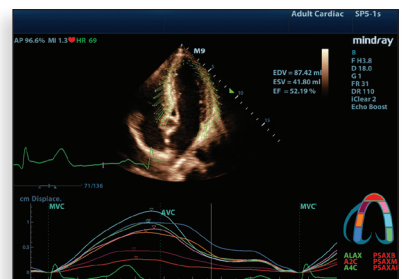

Vector imaging with tissue tracking QA



## Vascular

Delivering excellence in color Doppler sensitivity with intuitive workflow, vascular imaging with the M9 is fast, accurate, and consistent.

- Auto IMT
- iWorks™ with iNsert™ automated exam protocols

## Emergency Department

With its premium performance, the M9 provides diagnostic confidence for immediate patient care decisions. Extreme portability, 3+ hour battery life, and specialized applications, make the M9 an ideal partner during emergent situations.

## Critical Care

The M9 is an excellent choice for critical patient examinations in intensive care environments. TEE probe compatibility and streamlined workflow are supported for bedside application.

## Anesthesia

With its compact size and advanced features, including iNeedle™ visualization, dedicated nerve exam presets, and TEE transducer, the M9 is an ideal system for nerve block and intraoperative cardiac monitoring. The M9's intuitive workflow makes operation efficient for the demanding OR environment.

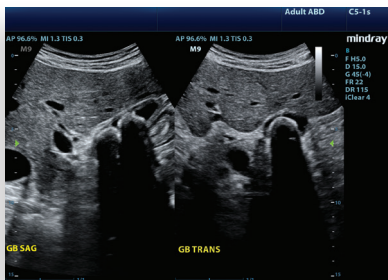

Gallbladder stones

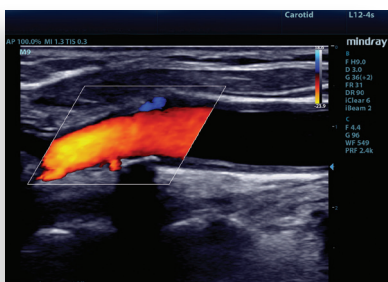

Carotid artery with thickened intima and calcification

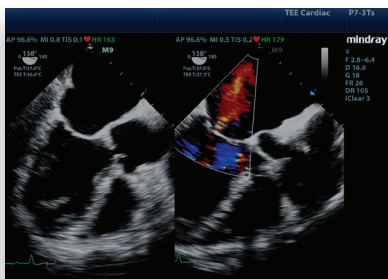

TEE of mitral regurgitation

# powerful | versatile | **mobile**

The M9, with its slim profile, is easy to transport and store. Whether mounted on the user-friendly ergonomic cart or hand-carried, the M9 advanced technologies provide the versatility to support the shared service environment with multiple clinical applications.





- Mindray Global Offices
- ◉ Mindray R&D / Mfg Operations

## Exceptional service and support

Mindray is a global medical device business with three established segments: Patient Monitoring and Life Support Products, Medical Imaging Systems, and *In-Vitro* Diagnostic Products. With more than 8,000 employees and R&D centers on three continents, we offer the medical community a range of innovative solutions designed to ensure the highest quality of care, while containing costs.

Purchase from Mindray includes system installation and comprehensive clinical training by Mindray's specialists. Additionally, technical remote support is available 24 hours a day, 7 days a week, at no charge.

Our dedicated field service team and in-house technical support organization represent one of the largest direct service teams in the industry. Individually and collectively they are committed to enhancing patient care while protecting your investment.

Learn how we can help you maximize your resources, with some of the most advanced and affordable devices in the industry.

For more information about Mindray products and services, visit [www.mindray.com](http://www.mindray.com).

**MR**  
**LISTED**  
**NYSE.**

Mindray DS USA, Inc.  
800 MacArthur Blvd., Mahwah, NJ USA 07430  
Tel: 800.288.2121 or 201.995.8000 Fax: 800.926.4275 [www.mindray.com](http://www.mindray.com)

©2014 Mindray DS USA, Inc. Subject to change. Mindray® is a registered trademark of Shenzhen Mindray Bio-Medical Electronics Co. Ltd. 10/14 P/N: 0002-08-40093 RevA



Mindray North America Headquarters  
Mahwah, NJ

**mindray**  
NORTH AMERICA